

Data Sheet



Article number: 2302166452

Description: E+G Lobe knobs
VC.692/50 SST-p-M8x20

Measures

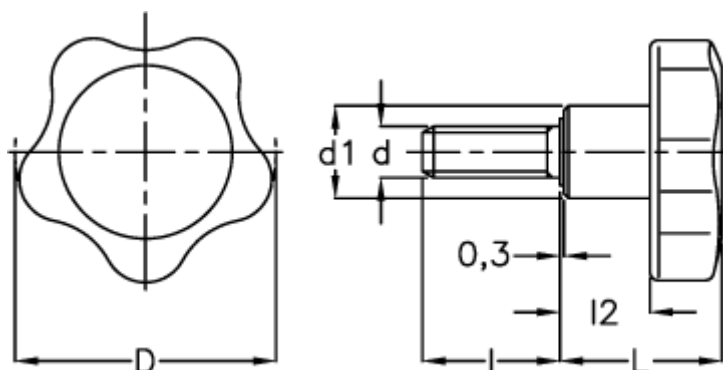

D	= 50
d1	= 18
d 6g	= M8
l	= 20
L	= 31
l2	= 17